

Moxa PoE Media Converter

IMC-P101 Hardware Installation Guide

First Edition, November 2009



© 2009 Moxa Inc. All rights reserved.
Reproduction without permission is prohibited.

Fl.4, No.135, Lane 235, Pao-Chiao Rd. Shing Tien City, Taipei, Taiwan,
R.O.C.

TEL: +886-2-8919-1230

P/N: 1802001015010

Overview

The IMC-P101 series is an Ethernet to fiber optic media converter. It provides Ethernet media conversion from 10/100 BaseT(X) to 100 BaseFX(SC/ST connectors). These media converters are classified as power source equipment (PSE), and when used in this way, the IMC-P101 series provides up to 15.4 watts to powered devices (PD). The IMC-P101 series can be used to power IEEE 802.3af compliant powered devices (PD), eliminating the need for additional wiring, and supports IEEE 802.3/802.3u/802.3x with 10/100M, full/half-duplex, and MDI/MDI-X auto-sensing to provide a total solution for your industrial Ethernet network.

The IMC-P101 Series includes the following models:

- **IMC-P101-M-SC:** PoE Industrial 10/100BaseT(X) to 100BaseFX media converter, multi-mode port with SC connector, 0 to 60°C operating temperature.
- **IMC-P101-M-ST:** PoE Industrial 10/100BaseT(X) to 100BaseFX media converter, multi-mode port with ST connector, 0 to 60°C operating temperature.
- **IMC-P101-S-SC:** PoE Industrial 10/100BaseT(X) to 100BaseFX media converter, single-mode port with SC connector, 0 to 60°C operating temperature.
- **IMC-P101-S-ST:** PoE Industrial 10/100BaseT(X) to 100BaseFX media converter, single-mode port with ST connector, 0 to 60°C operating temperature.
- **IMC-P101-M-SC-T:** PoE Industrial 10/100BaseT(X) to 100BaseFX media converter, multi-mode port with SC connector, -40 to 75°C operating temperature.
- **IMC-P101-M-ST-T:** PoE Industrial 10/100BaseT(X) to 100BaseFX media converter, multi-mode port with ST connector, -40 to 75°C operating temperature.
- **IMC-P101-S-SC-T:** PoE Industrial 10/100BaseT(X) to 100BaseFX media converter, single-mode port with SC connector, -40 to 75°C operating temperature.
- **IMC-P101-S-ST-T:** PoE Industrial 10/100BaseT(X) to 100BaseFX media converter, single-mode port with ST connector, -40 to 75°C operating temperature.

NOTE *Throughout this Hardware Installation Guide, we often use **IMC** as an abbreviation for Moxa Industrial Media Converter:*

IMC = Moxa Industrial Media Converter

Package Checklist

Moxa PoE Media Converter is shipped with the following items. If any of these items is missing or damaged, please contact your customer service representative for assistance.

- IMC-P101 series media converter.
- Hardware Installation Guide (printed).
- Warranty Card.

Features

- 10/100BaseT(X) Auto-Negotiation and Auto-MDI/MDI-X.
- IEEE 802.3af compliant PoE.
- Power failure by relay output.
- Provides up to 15.4W of power to powered devices (PD).
- Support Store-and-Forward mode and Pass Through mode.
- -40 to 75°C operating temperature range (T models).
- Redundant dual VDC power inputs.

Panel Layout of the IMC-P101 Series

Top Panel View

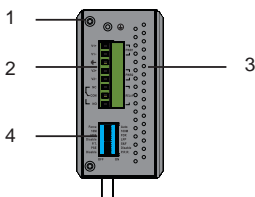

1. Grounding screw
2. Terminal block for power input PWR1/PWR2
3. Heat dissipation vents and relay output
4. DIP switch

Front Panel View (IMC-P101-M-ST)

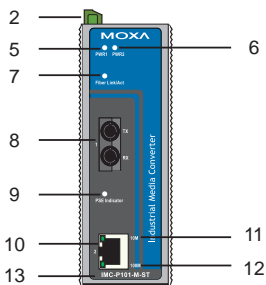

5. Power input PWR1 LED
6. Power input PWR2 LED
7. Fiber Link/Active LED
8. 100BaseFX (ST/SC connector) Port
9. PSE Indicator LED
10. 10/100BaseT(X)
11. TP port 10 Mbps LED
12. TP port 100 Mbps LED
13. Model Name
14. Screw hole for wall mounting kit
15. DIN-Rail mounting kit

Rear Panel View

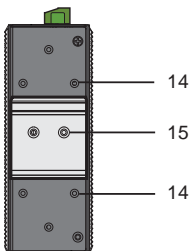

Mounting Dimensions

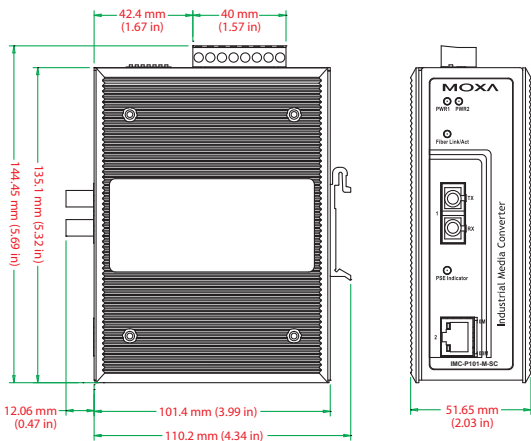

Side View

Front View

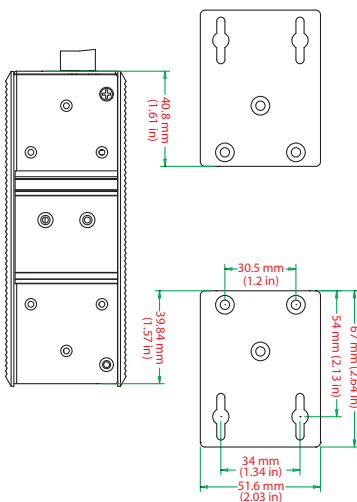

Rear View

Panel Mounting Kit (Optional)

DIN-Rail Mounting

The aluminum DIN-Rail attachment plate should be fixed to the back panel of the IMC when you take it out of the box. If you need to reattach the DIN-Rail attachment plate to the IMC, make sure the stiff metal spring is situated towards the top, as shown in the figures below.

STEP 1:

Insert the top of the DIN-Rail into the slot just below the stiff metal spring.

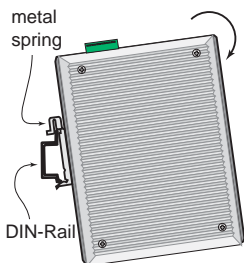

STEP 2:

The DIN-Rail attachment unit will snap into place as shown below.

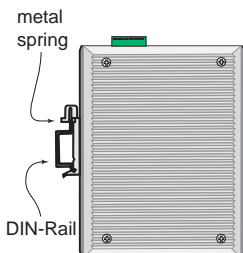

To remove the Moxa Industrial Media Converter from the DIN-Rail, simply reverse Steps 1 and 2 above.

Wall Mounting (Optional)

For some applications, you will find it convenient to mount the Moxa PoE Media Converter on the wall, as illustrated below.

STEP 1:

Remove the aluminum DIN-Rail attachment plate from the Moxa PoE Media Converter, and then attach the wall mount plates, as shown in the diagrams below.

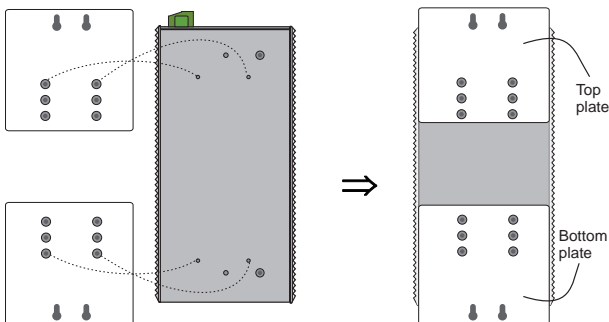

STEP 2:

Mounting the Moxa PoE Media Converter on the wall requires 4 screws. Use the IMC, with wall mount plates attached, as a guide to mark the correct locations of the 4 screws. The heads of the screws should be less than 6.0 mm in diameter, and the shafts should be less than 3.5 mm in diameter, as shown in the figure at the right.

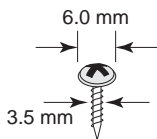

NOTE Test the screw head and shank size by inserting the screw into one of the keyhole shaped apertures of the Wall Mounting Plates, before it is screwed into the wall.

Do not screw the screws in all the way—leave a space of about 2 mm to allow room for sliding the wall mount panel between the wall and the screws.

STEP 3:

Once the screws are fixed in the wall, insert the four screw heads through the large openings of the keyhole-shaped apertures, and then slide Moxa PoE Media Converter downwards, as indicated below. Tighten the four screws for added stability.

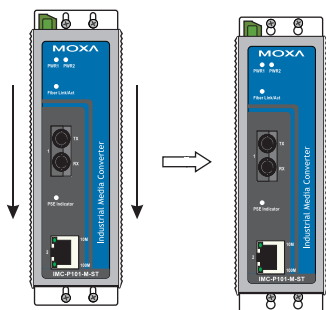

Grounding the Moxa Industrial Media Converter

Grounding and wire routing help limit the effects of noise due to electromagnetic interference (EMI). Run the ground connection from the ground screw to the grounding surface prior to connecting devices.

ATTENTION



This product is intended to be mounted to a well-grounded mounting surface such as a metal panel.

Wiring the Redundant Power Inputs

The top five contacts of the 8-contact terminal block connector on the IMC's top panel are used for the IMC's two DC inputs. Top and front views of one of the terminal block connectors are shown here.

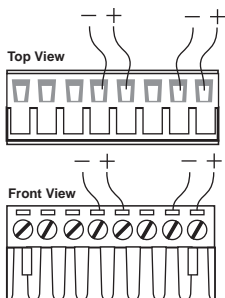

STEP 1: Insert the negative/positive DC wires into the V-/V+ terminals.

STEP 2: To keep the DC wires from pulling loose, use a small flat-blade screwdriver to tighten the wire-clamp screws on the front of the terminal block connector.

STEP 3: Insert the plastic terminal block connector prongs into the terminal block receptor, which is located on the IMC's top panel.

ATTENTION



Before connecting the IMC to DC power inputs, make sure the DC power source voltage is stable.

Communication Connections

IMC-P101 models have one 10/100BaseT(X) Ethernet port, and one 100BaseFX (SC or ST type connector) fiber port.

10/100BaseT(X) Ethernet Port Connection

The 10/100BaseT(X) Ethernet port located on the IMC's front panel is used to connect to Ethernet-enabled devices.

Illustrated below are pinouts for both MDI (NIC-type) ports and MDI-X (HUB/Switch-type) ports, and also cable wiring diagrams for straight-through and cross-over Ethernet cables.

RJ45 (8-pin, MDI) Port Pinouts

Pin	Signal
1	Tx+
2	Tx-
3	Rx+
6	Rx-

RJ45 (8-pin, MDI-X) Port Pinouts

Pin	Signal
1	Rx+
2	Rx-
3	Tx+
6	Tx-

RJ45 (8-pin) to RJ45 (8-pin) Straight-Through Cable Wiring

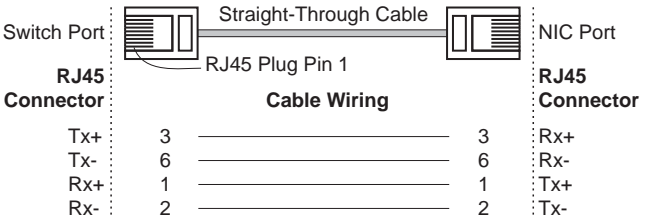

RJ45 (8-pin) to RJ45 (8-pin) Cross-Over Cable Wiring

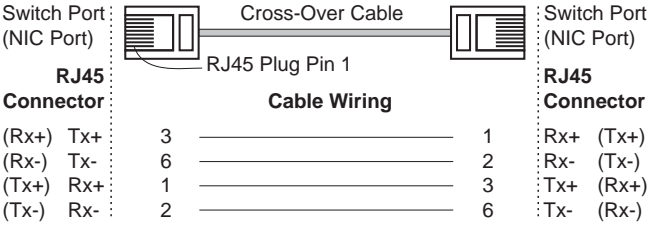

100BaseFX Ethernet Port Connection

The concept behind the SC port and cable is quite straightforward. Suppose you are connecting devices I and II. Unlike electrical signals, optical signals do not require a circuit in order to transmit data. Consequently, one of the optical lines is used to transmit data from device I to device II, and the other optical line is used to transmit data from device II to device I, for full-duplex transmission.

All you need to remember is to connect the Tx (transmit) port of device I to the Rx (receive) port of device II, and the Rx (receive) port of device I to the Tx (transmit) port of device II. If you are making your own cable, we suggest labeling the two sides of the same line with the same letter (A-to-A and B-to-B, as shown below, or A1-to-A2 and B1-to-B2).

SC-Port Pinouts

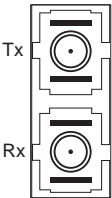

SC-Port to SC-Port Cable Wiring

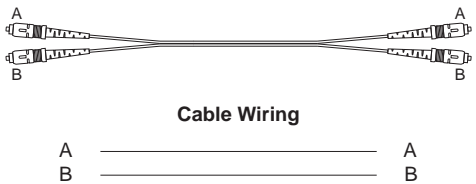

ST-Port Pinouts

ST-Port to ST-Port Cable Wiring



Cable Wiring

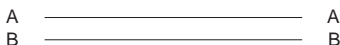

ATTENTION



This is a Class 1 Laser/LED product. Do not stare into the Laser Beam.

Redundant Power Inputs

Both power inputs can be connected simultaneously to live DC power sources. If one power source fails, the other live source acts as a backup, and automatically supplies all of the Moxa Industrial Media Converter’s power needs.

DIP Switch Setting

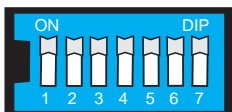

DIP No.	Function	ON	OFF
1	Auto Negotiation	Enable*	Disable
<p>“ON”: Enables “Auto Negotiation” function, the speed and duplex states for each port link segment are automatically configured using the highest performance interoperation mode.</p> <p>“OFF”: Disables “Auto Negotiation” function, the speed and duplex states depend on the manual setting configuration.</p>			
2	Force TP Speed	100Mbps*	10Mbps
<p>(Only when Auto Negotiation is disabled)</p> <p>“ON”: Forces 100Mbps on Ethernet port.</p> <p>“OFF”: Forces 10Mbps on Ethernet port.</p>			
3	Force TP Duplex	Full Duplex*	Half Duplex
<p>(Only when Auto Negotiation is disabled)</p> <p>“ON”: Forces Full Duplex on Ethernet port.</p> <p>“OFF”: Forces Half Duplex on Ethernet port.</p>			
4	Link Fault Pass Through	Enable*	Disable
<p>“ON”: Enables “Link Fault Pass Through”, the link status on the TX port will inform the FX port of the same device and vice versa.</p> <p>“OFF”: Disables “Link Fault Pass Through”, the link status on the TX port will not inform the FX port.</p>			
5	Operating Mode	Store-and-Forward*	Pass Through

DIP No.	Function	ON	OFF
	<p>“ON”: Selects “Store-and-Forward” mode, begins to forward a packet to a destination port after an entire packet is received. The latency depends on the packet length.</p> <p>“OFF”: Selects “Pass Through” mode, operates with the minimum latency. Both transceivers are interconnected via internal MIIs and the internal switch engine and data buffer are not used.</p> <p>Note: With “Pass Through” mode enabled, the Ethernet port and fiber port should transmit at 100 Mbps, which is equivalent to full duplex mode.</p>		
6	PSE	Disable	Enable*
	<p>PSE: Power Source Equipment.</p> <p>“ON”: Disables “PSE”, IMC-P101 series do NOT provide power to PD (Powered Device).</p> <p>“OFF”: Enables “PSE”, IMC-P101 series provides power to PD (Powered Device).</p>		
7	P.R.R.	Enable	Disable*
	<p>P.R.R.: Power Remote Reset</p> <p>“ON”: Enables “P.R.R” function, when fiber port link down 3 seconds and “PSE” setting is enabled, IMC-P101 series STOP providing power to PD (Power Device) which means the PD power will turn OFF. After 1 second later, IMC-P101 series start to continue provide power to PD, and then the PD power turn back ON for reset PD.</p> <p>“OFF”: Disables “P.R.R” function, no reset PD function.</p>		

(*): **Default DIP switch setting.**

ATTENTION



After changing the DIP switch setting, you will need to power off and then power on the IMC-P101 to activate the new setting.

LED Indicators

The front panel of Moxa Industrial Media Converter contains several LED indicators. The function of each LED is described in the table below.

LED	Color	State	Description
PWR1	Green	ON	Power is being supplied to power input PWR1
		OFF	Power is not being supplied to power input PWR1
PWR2	Green	ON	Power is being supplied to power input PWR2
		OFF	Power is not being supplied to power input PWR2
Fiber Link/Act	Green	ON	Fiber port is active.
		Blinking	Data is being transmitted or received.
		OFF	Fiber port is inactive.
PSE Indicator	Green	ON	PSE is enabled.
		1 Flash	Low Signature Resistance
		2 Flash	High Signature Resistance

		5 Flash	Power overload Fault
		9 Flash	Power Management Allocation Exceeded
10M	Yellow	ON	Ethernet port 10 Mbps link is active.
		Blinking	Data is being transmitted at 10 Mbps.
		OFF	Ethernet port 10 Mbps link is inactive.
100M	Green	ON	Ethernet port 100 Mbps link is active.
		Blinking	Data is being transmitted at 100 Mbps.
		OFF	Ethernet port 100 Mbps link is inactive.

Specifications

Technology

Standards IEEE 802.3 for 10BaseT,
IEEE 802.3u for 100BaseT(X), 100BaseFX
IEEE 802.3af for Power-over-Ethernet

Interface

RJ45 ports 10/100BaseT(X)
Fiber ports 100BaseFX (SC, ST connectors available)
LED Indicators PWR1, PWR2, Fiber Link/Act, 10/100M (Ethernet port), PSE Indicator

DIP Switches:

Dip No.	Function	ON	OFF
1	Auto Negotiation	Enable*	Disable
2	Force TP Speed	100Mbps*	10Mbps
3	Force TP Duplex	Full Duplex*	Half Duplex
4	Link Fault Pass Through	Enable*	Disable
5	Operating Mode	Store-and-Forward*	Pass Through
6	PSE	Disable	Enable*
7	P.R.R. (PD Remote Reset)	Enable	Disable*

(*): Default DIP switch setting.

Alarm Contact One relay output with current carrying capacity of 1A @ 24 VDC

Optical Fiber

	100BaseFX	
	Multi-mode	Single-mode
Wavelength	1300 nm	1310 nm
Max. TX	-10 dBm	0 dBm
Min. TX	-20 dBm	-5 dBm
RX Sensitivity	-32 dBm	-34 dBm
Link Budget	12 dB	29 dB
Typical Distance	5 km ^a 4 km ^b	40 km ^c
Saturation	-6 dBm	-3 dBm

- | |
|---|
| a. 50/125 μm , 800 MHz*km fiber optic cable |
| b. 62.5/125 μm , 500 MHz*km fiber optic cable |
| c. 9/125 μm , 3.5 PS/(nm*km) fiber optic cable |

Physical Characteristics

Housing	Metal
Dimensions (W x H x D)	144.45 x 110.2 x 51.65 mm (5.69 x 4.34 x 2.03 in)
Weight	Product only: 525g Packaged: 710g
Installation	DIN-Rail mounting, Wall Mounting (optional kit)

Environmental Limits

Operating Temperature	
Standard Models:	0 to 60°C (32 to 140 °F)
Wide Temp. Models:	-40 to 75°C (-40 to 167 °F)
Storage Temperature	-40 to 85°C (-40 to 185 °F)
Ambient Relative Humidity	5 to 90% (non-condensing)

Power Requirements

Input Voltage	48VDC (46 to 57 VDC), redundant inputs
Power Consumption	430mA@48VDC (max.)
Connection	Removable terminal block
Overload Current Protection	1.6 A (protects against two signals shorted together)
Reverse Polarity Protection	Present

Regulatory Approvals

Safety	UL508
EMI	FCC Part 15, CISPR (EN55022) class A
EMS	IEC 61000-4-2 Edition 1.2: 2001-04(Level 4) EN 61000-3-3: 1995 + A1: 2001 IEC 61000-4-3: 2002+A1: 2002(Level 3) IEC 61000-4-4: 2004(Level 4) IEC 61000-4-5 Edition 1.1: 2001-04(Level 3) IEC 61000-4-6 Edition 2.1: 2004-11(Level 3) IEC 61000-4-8 Edition 1.1: 2001-03(Level 3) IEC 61000-4-11 Second Edition: 2004-03
Shock	IEC 60068-2-27
Free Fall	IEC 60068-2-32
Vibration	IEC 60068-2-6

Warranty

Warranty Period	5 years Details: See www.moxa.com/warranty
-----------------	--

Technical Support Contact Information

www.moxa.com/support

Moxa Americas:

Toll-free: 1-888-669-2872

Tel: +1-714-528-6777

Fax: +1-714-528-6778

Moxa China (Shanghai office):

Toll-free: 800-820-5036

Tel: +86-21-5258-9955

Fax: +86-10-6872-3958

Moxa Europe:

Tel: +49-89-3 70 03 99-0

Fax: +49-89-3 70 03 99-99

Moxa Asia-Pacific:

Tel: +886-2-8919-1230

Fax: +886-2-8919-1231